

# Noise-induced narrowing of peaks in the power spectra of underdamped nonlinear oscillators

M. I. Dykman

*Institute of Semiconductors, Academy of Sciences of the Ukrainian Soviet Socialist Republic, Kiev, U.S.S.R.*

R. Mannella\* and P. V. E. McClintock

*Department of Physics, University of Lancaster, Lancaster LA1 4YB, England*

S. M. Soskin

*Institute of Semiconductors, Academy of Sciences of the Ukrainian Soviet Socialist Republic, Kiev, U.S.S.R.*

N. G. Stocks

*Department of Physics, University of Lancaster, Lancaster LA1 4YB, England*

(Received 2 April 1990)

The spectral densities of the fluctuations of noise-driven underdamped nonlinear oscillators are discussed with particular reference to the large class of systems whose eigenfrequencies vary non-monotonically with energy. It is shown by analog electronic experiments and theoretically that, astonishingly, the widths of their spectral peaks can sometimes *decrease* with increasing noise intensity  $T$ . The specific system studied, as an example, is the single-well Duffing oscillator in a constant homogeneous field. An explicit expression is derived in terms of  $T$  and a field parameter for the shape of the spectral peak. It is shown to be in good agreement with experiment. The possibility of observing such spectral features for localized and resonant vibrations of impurities in solids is discussed.

## I. INTRODUCTION

A revealing characteristic feature of noise-driven nonlinear systems is the spectral density of their fluctuations. Where a system is in thermal equilibrium this determines, in particular, its (frequency-dependent) susceptibility via the fluctuation-dissipation theorem.<sup>1</sup> The power spectra of underdamped systems are of special interest in this respect because they include narrow peaks related to small-amplitude vibrations of the system about its equilibrium positions. These peaks enable the fundamental characteristics of the system, such as its eigenfrequencies and relaxation times, to be investigated.

For very weak noise the peaks are narrow and symmetrical but, as the noise intensity increases, their shapes change because of the nonlinearity of the eigenoscillations, which gives rise to a dependence of their frequency  $\omega(E)$  on their energy  $E$ . Consequently, the noise-induced energy straggling  $\Delta E$  gives rise to a corresponding frequency straggling  $\Delta\omega$ . When the latter exceeds the uncertainty in frequency due to relaxation, the shape of the principal spectral peak is determined primarily by nonlinearity. For small  $E$  (we set  $E$  equal to zero at the equilibrium position), the dependence of  $\omega(E)$  on  $E$  is linear in the general case; the frequency straggling and the characteristic width of the spectral peak will also increase linearly with noise intensity  $T$ , therefore, if we assume that  $\Delta E \sim T$  as is usually the case. In view of the importance of the problem, the power spectra of classical vibrational systems have been considered by many authors, both numerically and analytically (see, for example, Refs. 2–10 and the reviews in Refs. 11 and 12). Explicit ana-

lytic expressions for the shapes of spectral peaks of underdamped systems driven by white noise have already been obtained;<sup>4,7</sup> see also Ref. 10.

A peculiar situation of particular interest arises when the dependence of  $\omega(E)$  on  $E$  is significantly nonlinear and the slope  $|d\omega(E)/dE|$  decreases with increasing  $E$ . In such cases there can in principle occur some *narrowing* of the central part of the spectral peak with increasing noise intensity. This seemingly bizarre possibility arises because the range of  $E$  for which  $\omega(E)$  is flatter comes into play and, as the noise intensity (and hence the amplitude and energy of the vibrations) is increased, so that the frequency straggling is partially suppressed by noise.

The peak narrowing phenomenon may be expected to be most pronounced in underdamped systems for which the function  $\omega(E)$  possesses an extremum at some energy  $E_e$ , i.e.,

$$\left. \frac{d\omega(E)}{dE} \right|_{E_e} = 0. \quad (1)$$

Indeed, if frequency straggling is the dominant broadening mechanism, then the spectral density of fluctuations  $Q(\Omega)$  for a given  $\Omega$  is formed from eigenvibrations with frequencies  $\omega(E)=\Omega$  (cf. Ref. 3). Consequently,  $Q(\Omega)$  is proportional to the “density” of vibrations of the relevant frequency, i.e., to  $|d\omega(E)/dE|^{-1}$  with  $\omega(E)=\Omega$  (the higher harmonics also contribute to  $Q(\Omega)$ , their contributions being proportional to  $|d\omega(E)/dE|^{-1}$  calculated for  $n\omega(E)=\Omega$  with  $n=2,3,\dots$ ; cf. Ref. 7). The divergence of  $Q(\Omega)$  at  $\Omega=\omega(E_e)$  in the zero-damping limit when (1) is fulfilled has already been noted.<sup>13</sup> Relaxation effects

will naturally tend to smear the singularity but, for small enough damping, there should be a distinct “zero-dispersion” peak<sup>13</sup> at  $\Omega = \omega(E_e)$ .

The zero-dispersion peak will be resolved only if the damping is extremely weak. Nonetheless, the existence of the  $|d\omega(E)/dE|^{-1} \rightarrow \infty$  singularity in the zero-damping limit will play an important role in the formation of the spectral peak for noise intensities  $T \sim E_e$ . The increased noise effectively “suppresses” the broadening of  $Q(\Omega)$  arising from frequency straggling and the spectral peak may become narrower as a result.

The phenomenon of noise-induced narrowing of the spectral peak was first observed in the analog electronic experiments described below and the theory of the effect was developed subsequently. In Sec. II below a simple model of a nonlinear oscillator displaying nonmonotonicity of its eigenfrequency with energy is described and the theoretical description of its spectral peak is reduced to a boundary value problem for an ordinary second-order differential equation. Section III presents the results of an experimental investigation of the spectral density of fluctuations in an analog electronic model of the system, for a wide range of parameters. The experimental results are compared with the theory in Sec. IV, and a qualitative and quantitative explanation of the observed features is proposed. Section V presents concluding remarks.

## II. THEORY OF THE SPECTRAL PEAK NEAR THE OSCILLATOR EIGENFREQUENCY

### A. Model

The system considered in the present paper is an asymmetric oscillator with fourth-order nonlinearity. Its Hamiltonian function in terms of dimensionless coordinate  $q$  and momentum  $p$  is of the form

$$H(p, q) = \frac{1}{2}p^2 + U(q), \quad U(q) = Aq + \frac{1}{2}q^2 + \frac{1}{4}q^4. \quad (2)$$

This model is interesting not only because, although extremely simple, it demonstrates some unusual kinetic features, but also because it is directly related to local and resonant vibrations in certain doped crystals (see, for example, Ref. 14). The term linear in  $q$  arises for inversely symmetrical defects when an electric field or external pressure is applied to the crystal, readily enabling the parameter  $A$  in (2) to be varied. As demonstrated below, this variation causes significant changes in the spectral density of fluctuations of the oscillator.

The term  $Aq$  in (2) shifts the equilibrium position  $q_{\text{eq}}$  of the oscillator from zero to a new value determined by the real solution of

$$q_{\text{eq}}^3 + q_{\text{eq}} + A = 0, \quad (3)$$

which is readily shown to be

$$q_{\text{eq}} = \left[ -\frac{A}{2} + \left( \frac{A^2}{4} + \frac{1}{27} \right)^{1/2} \right]^{1/3} + \left[ -\frac{A}{2} - \left( \frac{A^2}{4} + \frac{1}{27} \right)^{1/2} \right]^{1/3}.$$

The dependence of the eigenfrequency  $\omega(E)$  of the oscillations on the energy  $E$  of the oscillator [measured from the bottom of the potential well, i.e., from  $U(q_{\text{eq}})$ ] and on the parameter  $A$  can be found from the expressions

$$\begin{aligned} \omega(E) &= \frac{\pi}{2K(k)} (\frac{1}{2}z^{(1)}z^{(2)})^{1/2}, \\ k^2 &= \frac{1}{4} \frac{(q^{(1)} - q^{(2)})^2 - (z^{(1)} - z^{(2)})^2}{z^{(1)}z^{(2)}} \\ z^{(j)} &= [(q^{(3)} - q^{(j)})(q^{(4)} - q^{(j)})]^{1/2}, \quad j=1,2 \end{aligned} \quad (4a)$$

where  $q^{(1)}, q^{(2)}$  are real roots and  $q^{(3)}, q^{(4)} \equiv q^{(3)*}$  are complex conjugate roots of the equation

$$U(q^{(n)} + q_{\text{eq}}) - U(q_{\text{eq}}) - E = 0, \quad n=1, \dots, 4, q^{(1)} > q^{(2)}, \quad (4b)$$

and where  $K(k)$  is an elliptic integral of the first kind and  $k$  is its modulus. The function  $\omega(E)$  is plotted for several values of  $A$  in Figs. 1(a) and 1(b).

The “eigenfrequency of the oscillator”  $\omega_0$ , defined as the frequency at the bottom of the potential well,

$$\omega_0 = \omega(0) = (1 + 3q_{\text{eq}}^2)^{1/2}, \quad (5)$$

increases monotonically with increasing  $|A|$ . At the same time, the slope of  $\omega(E)$  at  $E \rightarrow 0$  changes nonmonotonically. For  $|A| < A_c = 0.99$  it monotonically decreases: one can show using (3) and (4) [or immediately by applying the small  $E$  asymptotics of  $\omega(E)$  given in Ref. 15] that

$$\omega'_0 \equiv \left. \frac{d\omega(E)}{dE} \right|_{E=0} = \frac{3}{4} (1 - 7q_{\text{eq}}^2) / (1 + 3q_{\text{eq}}^2)^{5/2}. \quad (6)$$

For  $|A| = 8/7^{3/2} \simeq 0.43$  the slope is seen from (3), (6) to become zero. For higher  $|A|$ , the dependence of  $\omega(E)$  on  $E$  becomes nonmonotonic [cf. Fig. 1(c)]. It is just this nonmonotonicity that gives rise to substantial narrowing of the principal peak in the spectral density of the fluctuations as the noise intensity increases.

We shall analyze the fluctuations of the oscillator (2) supposing that it is subject to a linear friction force and additive white noise, so that the equation of motion is of the form

$$\begin{aligned} \ddot{q} + 2\Gamma\dot{q} + \frac{dU(q)}{dq} &= f(t), \\ \langle f(t)f(t') \rangle &= 4\Gamma T \delta(t - t'). \end{aligned} \quad (7)$$

The dimensionless friction coefficient  $\Gamma$  is assumed small,

$$\Gamma \ll 1,$$

so that the oscillator is underdamped. In the case where the noise  $f(t)$  results from thermal fluctuations in a bath and it is the coupling to the bath that gives rise to the friction force, the noise intensity parameter  $T$  represents the temperature of the bath. [An extension of the model (7) is discussed below].

### B. General expression for the shape of the spectral peak

To calculate the spectral density of the fluctuations of the coordinate  $q$

$$Q(\Omega) = \frac{1}{\pi} \operatorname{Re} \int_0^\infty dt e^{i\Omega t} \tilde{Q}(t), \quad (8)$$

$$\tilde{Q}(t) = \langle (q(t) - \langle q \rangle)(q(0) - \langle q \rangle) \rangle$$

for (7) it is convenient<sup>7</sup> to start from the Fokker-Planck equation (FPE) for the probability density

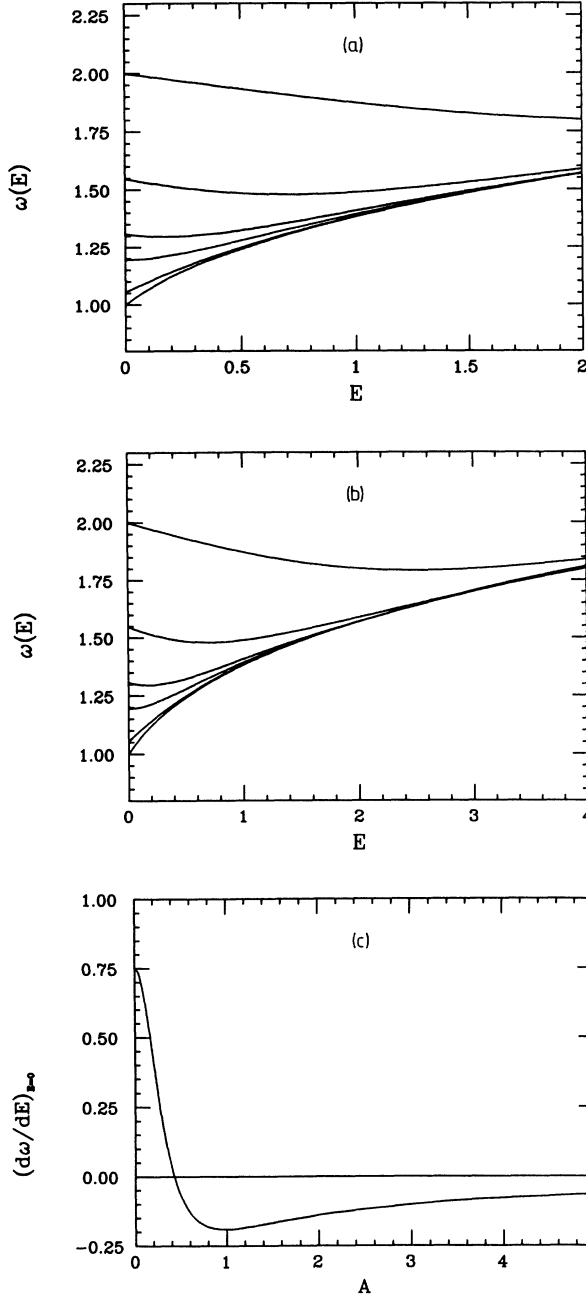

FIG. 1. (a) The dependence of the eigenfrequency  $\omega(E)$  of the oscillations on the energy  $E$  of the oscillator, measured from the bottom of the potential well, for several values of the inclination parameter  $A$ , calculated from Eqs. (4a) and (4b). The corresponding values of  $A$ , from bottom to top, were 0, 0.2, 0.43, 0.6, 1.0 and 2.0. (b) As in (a), but over a wider range of  $E$ . (c) The dependence on  $A$  of the initial gradient  $\omega'_0 = [d\omega(E)/dE]_{E=0}$  of the curves shown in (a), calculated from (5) and (6).

$w(q, p, t; q_0, p_0, 0)$  of the transition from the point  $(q_0, p_0)$  occupied at the instant 0 to the point  $(q, p)$  occupied at the instant  $t$ ,

$$\frac{\partial w}{\partial t} = -\frac{\partial}{\partial q}(pw) + \frac{\partial}{\partial p}[U'(q)w] + 2\Gamma\hat{L}w,$$

$$\hat{L}w = \frac{\partial}{\partial p}(pw) + T\frac{\partial^2 w}{\partial p^2}, \quad w \equiv w(q, p, t; q_0, p_0, 0), \quad (9)$$

$$w(q, p, 0; q_0, p_0, 0) = \delta(q - q_0)\delta(p - p_0).$$

(Note that  $w$  is a conditional probability density, and not a joint density.) According to the definition (8) we can express the time correlation function of the coordinate  $\tilde{Q}(t)$  in terms of  $w(q, p, t; q_0, p_0, 0)$  and of the stationary distribution  $w_{st}(q_0, p_0)$  as

$$\tilde{Q}(t) = \int dq dp (q - \langle q \rangle) \tilde{W}(q, p, t),$$

$$\tilde{W}(q, p, t) = \int dq_0 dp_0 (q_0 - \langle q_0 \rangle) \times w(q, p, t; q_0, p_0, 0) w_{st}(q_0, p_0), \quad (10)$$

$$w_{st}(q, p) = Z^{-1} \exp\{-[H(p, q) - U(q_{eq})]/T\},$$

$$Z = \int dq dp \exp\left\{-\frac{[H(p, q) - U(q_{eq})]}{T}\right\}.$$

The function  $\tilde{W}(q, p, t)$  satisfies the FPE (9) for  $w$ . For a further analysis, it is convenient to rewrite this equation in the energy-phase representation and to make the Fourier transform (8):

$$-i\Omega W + \omega(E) \frac{\partial W}{\partial \phi} = 2\Gamma\hat{L}'W + (q - \langle q \rangle) w_{st}(q, p),$$

$$W \equiv W(E, \phi; \Omega) = \int_0^\infty dt e^{i\Omega t} \tilde{W}(q, p, t), \quad (11)$$

$$q \equiv q(E, \phi), \quad p \equiv p(E, \phi).$$

The operator  $\hat{L}'$  in (11) coincides with the operator  $\hat{L}$  in (8) except that the differentiation with respect to  $p$  has been replaced by differentiation with respect to  $E$  and  $\phi$ ,

$$\hat{L}' = \left[ p \frac{\partial}{\partial E} - \omega(E) \frac{\partial q}{\partial E} \frac{\partial}{\partial \phi} \right] \times \left[ p \left[ 1 + T \frac{\partial}{\partial E} \right] - T\omega(E) \frac{\partial q}{\partial E} \frac{\partial}{\partial \phi} \right]. \quad (12)$$

We have also taken into account in (11) the initial condition  $\tilde{W}(q, p, 0) = (q - \langle q \rangle) w_{st}(q, p)$  which follows from (9) and (10). Like  $q(E, \phi)$  and  $p(E, \phi)$ , the function  $W(E, \phi; \Omega)$  is periodic in  $\phi$  with the period  $2\pi$ , and so it can be expanded in a Fourier series:

$$W(E, \phi; \Omega) = \sum_{n=-\infty}^{\infty} W_n(E, \Omega) \exp(in\phi). \quad (13)$$

On substituting (13) into (11) we obtain a set of equations for the function  $W_n(E, \Omega)$ :

$$\begin{aligned}
-i[\Omega - n\omega(E)]W_n(E, \Omega) &= 2\Gamma \sum_m \hat{L}'_{nm} W_m(E, \Omega) \\
&\quad + [q_n(E) - \langle q \rangle \delta_{n0}] w_{st}(E), \\
q_n(E) &= \frac{1}{2\pi} \int_0^{2\pi} d\phi \exp(-in\phi) q(E, \phi), \\
w_{st}(E) &= Z^{-1} \exp(-E/T).
\end{aligned} \tag{14}$$

It is evident that, to zeroth order in  $\Gamma$ , the function  $W_1(E, \Omega)$  has a pole at  $\Omega = \omega(E)$ . Although the singularity is smeared because of damping,  $|W_1(E, \Omega)|$  nonetheless remains large for the frequencies in question. It is clear from (14) that the functions  $W_n(E, \Omega)$  with  $n \neq 1$  within the frequency range where  $|\Omega - n\omega(E)| \gtrsim \omega_0 \gg \Gamma$  will be given to lowest order in  $\Gamma/\omega_0$  by

$$\begin{aligned}
W_n(E, \Omega) &\approx \frac{-2\Gamma}{i[\Omega - n\omega(E)]} L'_{n1} W_1(E, \Omega) \\
&\quad - \frac{q_n(E) - \langle q \rangle \delta_{n0}}{i[\Omega - n\omega(E)]} w_{st}(E), \\
|\Omega - n\omega(E)| &\gtrsim \omega_0 \gg \Gamma, \quad n \neq 1.
\end{aligned}$$

Their contribution to  $Q(\Omega)$  which, according to Eqs. (8) and (10)–(14), is determined by  $\text{Re} \sum_{n \neq 1} q_n^* W_n(E, \Omega)$  [cf. Eq. (19) below] and thus comes only from the first term on the right-hand side, contains the small parameter  $\Gamma/\omega_0$  and can therefore be neglected. The operators  $\hat{L}'_{nm}$  here are given by

$$\hat{L}'_{nm} = \frac{1}{2\pi} \int_0^{2\pi} d\phi \exp(-in\phi) \hat{L}' \exp(im\phi). \tag{15}$$

In the limit of small damping  $\Gamma \ll 1$  it usually suffices to retain only the diagonal terms  $\hat{L}'_{nm}$  ( $n=m$ ) in (14) where the *shape* of the spectral peak is analyzed. Indeed, the terms  $\propto \Gamma \ll 1$  in (14) are important only under resonance conditions, when  $|\Omega - n\omega(E)| \ll 1$  for the energies in question; but these conditions are not fulfilled for the same  $E$  and different  $n$  simultaneously (in particular for the system under consideration). The shape of the peak of  $Q(\Omega)$  near the eigenfrequency  $\omega_0$  is determined by the “resonant” function  $W_1(E, \Omega)$ . The equation for it, making allowance for expressions (12) and (15) for the diagonal term  $\hat{L}'_{11}$ , is of the form

$$\begin{aligned}
-i[\Omega - \omega(E)]W_1(E, \Omega) &= 2\Gamma \left[ 1 + p^2 \frac{d}{dE} \right] \left[ 1 + T \frac{d}{dE} \right] W_1(E, \Omega) \\
&\quad - 2\Gamma T \omega^2(E) \overline{(q_E)^2} W_1(E, \Omega) + q_1(E) w_{st}(E), \\
|\Omega - \omega(E)| &\ll \omega_0,
\end{aligned} \tag{16}$$

$$\overline{p^2} \equiv \overline{p^2(E)} = \frac{1}{2\pi} \int_0^{2\pi} d\phi p^2(E, \phi),$$

$$\overline{(q_E)^2} \equiv \overline{(q_E)^2(E)} = \frac{1}{2\pi} \int_0^{2\pi} d\phi \left[ \frac{\partial q(E, \phi)}{\partial E} \right]^2.$$

The boundary conditions for Eq. (16) can easily be ob-

tained if one notes, on the one hand, that the function  $W(E, \phi, \Omega)$  vanishes for  $E \rightarrow \infty$  and, on the other hand, that it must remain finite as  $E \rightarrow 0$ . For small  $E$  the oscillator is practically harmonic, and so

$$\begin{aligned}
\overline{p^2} &\simeq E, \quad \overline{(q_E)^2} \simeq (4\omega_0^2 E)^{-1}, \\
q_1 &\simeq (E/2\omega_0^2)^{1/2} \quad (E \ll 1).
\end{aligned} \tag{17}$$

The solution of (16) and (17) for  $E \rightarrow 0$  can be seen to be either  $W_1 \propto E^{1/2}$  or  $W_1 \propto E^{-1/2}$ . So, allowing for the finiteness of  $W_1$ , we arrive at

$$W_1(0, \Omega) = 0, \quad W_1(E, \Omega) \rightarrow 0 \quad \text{for } E \rightarrow \infty. \tag{18}$$

The spectral density of the fluctuations in the region of the eigenfrequency  $\omega_0$ , when the main contribution to  $W(E, \phi, \Omega)$  in (13) comes from  $W_1(E, \Omega)$ , according to Eqs. (8) and (10)–(13), is given by the expression

$$\begin{aligned}
Q(\Omega) &\simeq Q_1(\Omega), \quad |\Omega - \omega_0| \ll \omega_0, \\
Q_1(\Omega) &= 2 \text{Re} \int_0^\infty dE \omega^{-1}(E) q_1^*(E) W_1(E, \Omega).
\end{aligned} \tag{19}$$

We note that for small  $\Gamma$  and not too large  $T$  there will also be relatively narrow peaks near the overtones, i.e., for  $\Omega \simeq n\omega_0$ . Their shapes are described by the function

$$\begin{aligned}
Q_n(\Omega) &= 2 \text{Re} \int_0^\infty dE \omega^{-1}(E) [q_n^*(E) - \langle q_n \rangle \delta_{n0}] W_n(E, \Omega), \\
\Omega &\simeq n\omega_0.
\end{aligned} \tag{20}$$

The intensities of these peaks are proportional to  $\langle |q_n - \langle q \rangle \delta_{n0}|^2 \rangle$  and they increase rapidly with increasing noise intensity  $T$  (as  $T^{1+|n-1|}$  for small  $T$ ). The narrowest of these peaks is that for  $n=0$ . Its evolution is investigated in detail in Ref. 16.

Calculated values of  $Q(\Omega)$  found from numerical solutions of (16) are shown (solid curves) in Figs. 2–4 for various parameter values and compared with experimental measurements (histograms, see Sec. III); the method for obtaining the coefficients in (16) is given in the Appendix.

### III. ANALOG EXPERIMENT

The analog electronic model of (7) was constructed on the basis of the design principles discussed previously.<sup>17</sup> A block diagram of the circuit is shown in Fig. 5. The damping coefficient  $\Gamma$  was made as small as practically possible; it was determined experimentally by measurement of the response of the circuit to very low amplitude sinusoidal forcing. The external noise was obtained from a Wandel and Golterman noise generator, model RG1, and taken to the circuit via an active single-pole filter of time constant  $\tau_N = 47.1 \mu\text{s}$  which was much longer than the correlation time (approximately  $8 \mu\text{s}$ ) of the noise output from the generator. The time constants of the two integrators in the circuit were both  $\tau_I = 2.74 \text{ ms} \gg \tau_N$ . The noise was therefore perceived by the circuit as being white and of intensity

$$T = \left[ \frac{\tau_N}{2\Gamma\tau_I} \right] \langle V_N^2 \rangle, \tag{21}$$

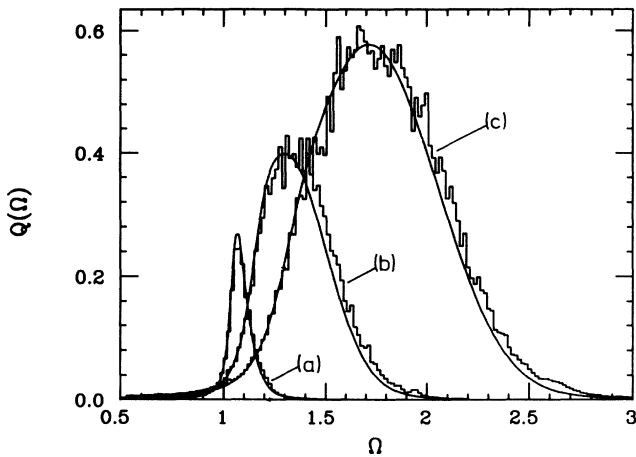

FIG. 2. Spectral density of the fluctuations  $Q(\Omega)$  of the oscillator (2) and (7) calculated (solid curves) from (16) and measured (histograms) for the analog electronic model, with the inclination parameter  $A=0$ , for noise intensities: (a)  $T=0.078$ ; (b)  $0.687$ ; (c)  $3.04$ .

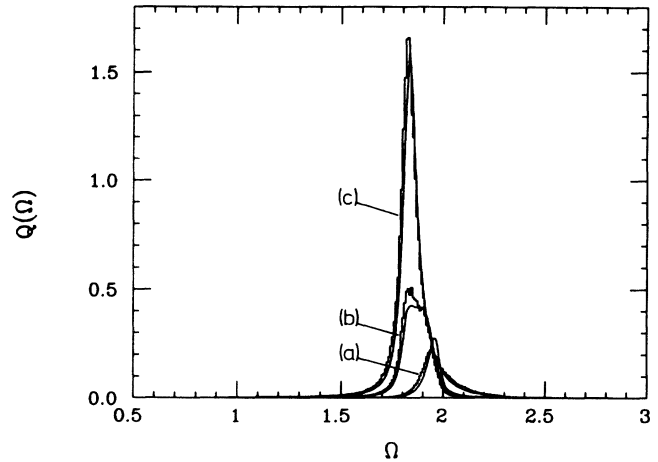

FIG. 4. Spectral density of the fluctuations  $Q(\Omega)$  of the oscillator (2) and (7) calculated (solid curves) from (16) and measured (histograms) for the analog electronic model with the inclination parameter  $A=2.0$ , for noise intensities: (a)  $T=0.078$ ; (b)  $0.687$ ; (c)  $3.04$ .

where  $\langle V_N^2 \rangle$  is the mean-square noise voltage.

The fluctuating  $x(t)$  from the circuit was analyzed by means of a Nicolet 1180 data processor. The signal was discretized into blocks of 512 samples, each of which was digitized with 12-bit precision. A standard fast Fourier transform (FFT) technique was applied to each block to determine the power spectral density  $Q(\Omega)$ , and the results were summation averaged. For the data presented below, each final  $Q(\Omega)$  represents an average of the analyses of 300 individual  $x(t)$  blocks. The data were recorded in the course of two separate experiments. For the initial investigation  $\Gamma=0.0150$ . Subsequently, after the (initially quite unexpected) spectral narrowing effect had been observed and identified as a phenomenon of some

considerable intrinsic interest, a second set of data was recorded; for this latter experiment the damping was slightly different, with  $\Gamma=0.0143$ . In the comparisons of experiment and theory that follow, some selected data from each of the experiments are presented, with the appropriate value of  $\Gamma$  being used for the corresponding theoretical curves in each case.

Some power spectral densities, typical of those measured for the electronic model of Fig. 5, are shown in Figs. 2-4. In each case, the spectrum consists of discrete points which have been joined to obtain a histogram.  $Q(\Omega)$  is plotted as a function of the normalized (to take account of the time scaling<sup>17</sup> of the circuit) dimensionless frequency  $\Omega/\Omega_0$  for which, in our circuit, we have set  $\Omega_0=1$ . [The measured  $Q(\Omega)$  at very small  $\Omega$  exhibits a zero frequency peak with a peculiar and very characteristic dependence on the magnitude of  $A$ ; this behavior, though interesting, is not connected to the subject matter of the present paper and it will be analyzed and discussed

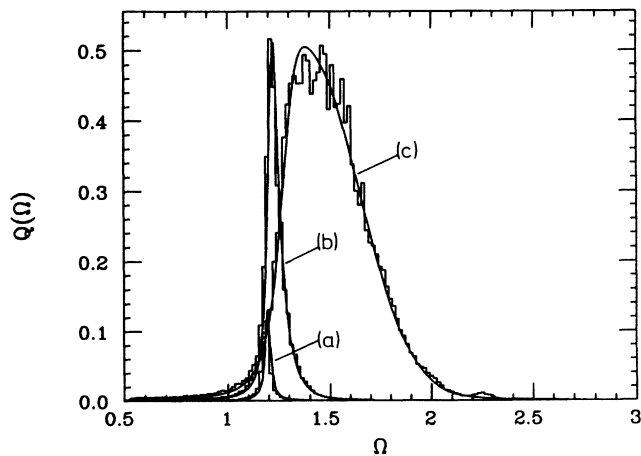

FIG. 3. Spectral density of the fluctuations  $Q(\Omega)$  of the oscillator (2) and (7) calculated (solid curves) from (16) and measured (histograms) for the analog electronic model with the inclination parameter  $A=0.43$  for noise intensities: (a)  $T=0.0191$ ; (b)  $0.154$ ; (c)  $1.15$ .

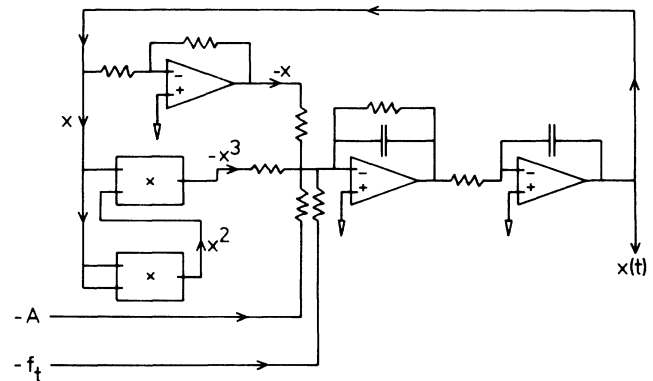

FIG. 5. Block diagram of the circuit used to model the system (2) and (7).

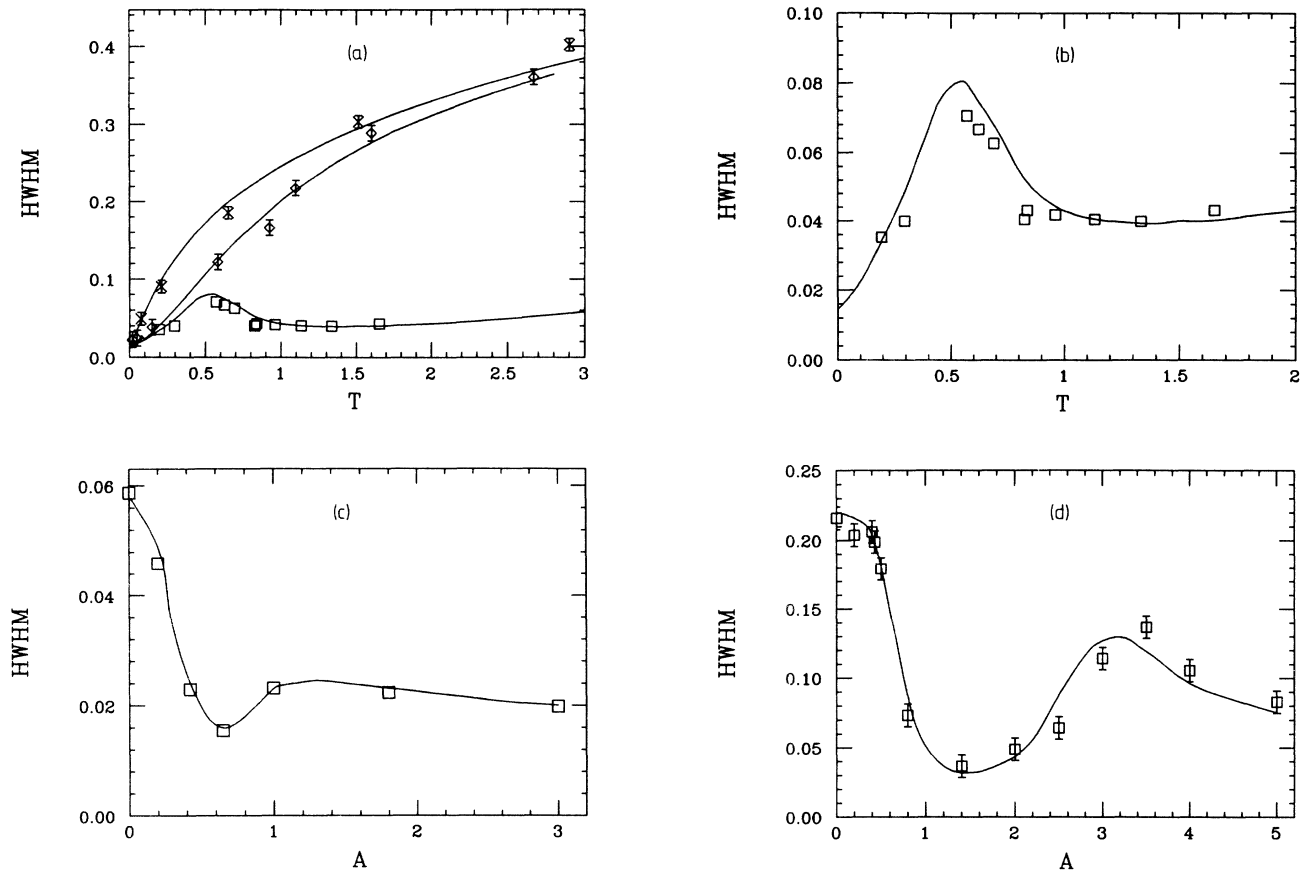

FIG. 6. The spectral width, defined as the half width at half maximum (HWHM),  $\delta\Omega$ , of the spectral peaks of the system (2) and (7) measured (data points) for the analog electronic model and calculated (solid curves) from (16) under different conditions. (a) Spectral width HWHM as a function of noise intensity  $T$  for three values of the inclination parameter:  $A=0$  ( $\times$ );  $0.43$  ( $\diamond$ );  $2.0$  ( $\square$ ). (b) As in (a), but plotted with an expanded ordinate scale for  $A=2.0$  to demonstrate more clearly the spectral narrowing phenomenon: there is a range of noise intensities  $T$  for which the HWHM markedly *decreases* with increasing  $T$ . (c) Spectral width, HWHM, as a function of the inclination parameter  $A$  for a noise intensity  $T=0.098$ . The experimental uncertainty is approximately the same size as the symbols. (d) Spectral width, HWHM, as a function of  $A$  for  $T=0.98$ .

elsewhere<sup>16</sup>]. Figure 6(a) demonstrates the effect on the half-width of changing the magnitude of the noise intensity  $T$  while keeping the inclination parameter  $A$  at a fixed value; Fig. 6(b) shows on an expanded vertical scale the data recorded for  $A=2.0$ . Figures 6(c) and 6(d) show the result of changing  $A$  while keeping  $T$  at fixed nonzero values.

A detailed discussion of the results is presented in Sec. IV below, but we may note immediately by inspection of Fig. 4 [see also Fig. 6(b)] one feature of particular interest: the narrowing of the spectral peaks with increasing noise intensity within a certain range of  $T$  and  $A$ .

#### IV. DISCUSSION OF RESULTS

It is evident from Figs. 2–4 that the power spectra calculated from Eqs. (16), (18), and (19), with parameter values taken from the experiment, fit the experimental spectra very closely (and we stress that there are no adjustable parameters at all in this comparison). To obtain

insight into the origin of the observed spectra, and into the underlying phenomena, we now consider in turn two ranges of noise intensity where different properties of the system manifest themselves.

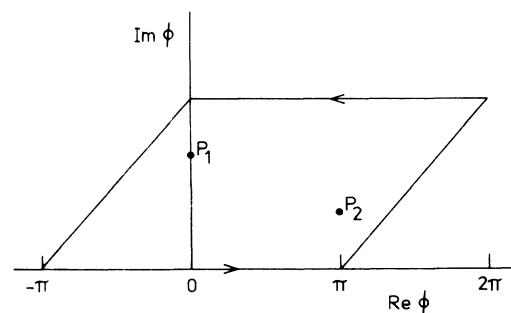

FIG. 7. Contour of integration for the determination of the harmonics of the coordinate.

### A. Weak noise range

A striking feature of underdamped nonlinear systems is the strong change of the spectral density of their fluctuations that occurs within a narrow range of low noise intensities. As mentioned above, this effect is attributable to a competition between the two superimposed broadening mechanisms: the purely relaxational one, and that due to noise-induced straggling of the eigenfrequency of the vibrations. Their contributions are comparable when

$$\delta\omega = |\omega(T) - \omega(0)| \sim \Gamma \quad (22)$$

with  $T \ll 1$ . Within the range of  $T$  given by (22), the shape of the peak of  $Q(\Omega)$  which is Lorentzian for  $T \rightarrow 0$ , changes to a complicated asymmetric distribution as shown in Figs. 2–4.

The peculiar feature of the system under consideration is the nonmonotonic dependence of the frequency straggling  $|\omega(T) - \omega(0)|$  on the inclination parameter  $|A|$  for  $T \ll 1$ . It is evident from Fig. 1(b) that because, to lowest order in  $T$ ,

$$|\omega(T) - \omega(0)| \propto |d\omega(E)/dE|_{E=0} T,$$

the function  $|\omega(T) - \omega(0)|$  has two maxima (for  $A=0$  and  $A \simeq 0.99$ ) and decreases for large  $|A|$  (as  $|A|^{-1}$  approximately). One would expect, therefore, that the dependence on  $A$  of the half-width at half maximum (HWHM)  $\delta\Omega$  of the peak of  $Q(\Omega)$  should be nonmonotonic for small  $T$ : it should follow approximately the dependence of  $|\omega'_0| = |d\omega(E)/dE|_{E=0}$  on  $A$  and, in particular, should be minimal for  $A \simeq 0.43$ . Such behavior of  $\delta\Omega$  is indeed evident in Figs. 6(c) and 6(d) where the theory is compared to the experimental data for two noise intensities.

Analytical results for the shape of the peak of  $Q(\Omega)$  in the small- $T$  region can be obtained if one notices that, within the whole range of  $T$  given by (22), i.e., even where the effects of noise are no longer small, the coefficients on the right-hand side of (16) are given by (17) to good accuracy. A solution of the relevant equation and an expression for  $Q(\Omega)$  for the case of the linear “dispersion law”, i.e.,

$$T|\omega''_0| \ll |\omega'_0|, \quad \omega'_0 = \left. \frac{d\omega(E)}{dE} \right|_{E=0}, \quad (23)$$

$$\omega''_0 = \left. \frac{d^2\omega(E)}{dE^2} \right|_{E=0}$$

was obtained in Refs. 4 and 7. For the system (2) and (7), in the range of values of  $|A|$  close to its critical value of  $|A| \simeq 0.43$  at which  $\omega'_0 = 0$ , it is also important to take account of the terms with  $\omega''_0$ . This can be done by perturbation theory in  $\omega''_0$ , using the method of generating functions proposed in Ref. 7. Here we give the explicit expression for  $Q(\Omega)$  in the limit of very small noise intensity  $T$  where the frequency straggling is small, implying that  $\delta\omega \ll \Gamma$ :

$$\begin{aligned} Q(\Omega) \simeq & \frac{T}{2\pi\omega_0^2} [R_L(\Gamma, \Delta)(1 + \frac{1}{2}\epsilon_1^2 + 3\epsilon_1\epsilon_2 + \frac{75}{16}\epsilon_2^2) \\ & - R_L(3\Gamma, \Delta)(\frac{1}{2}\epsilon_1^2 + 3\epsilon_1\epsilon_2 + \frac{9}{2}\epsilon_2^2) \\ & - \frac{3}{16}\epsilon_2^2 R_L(5\Gamma, \Delta) \\ & - \bar{R}(\Gamma, \Delta)(\epsilon_1^2 + 6\epsilon_1\epsilon_2 + \frac{39}{4}\epsilon_2^2)], \\ \Delta = & \Omega - \omega_0 - \Gamma(2\epsilon_1 + 3\epsilon_2), \end{aligned} \quad (24)$$

$$\epsilon_1 = \omega'_0 T / \Gamma, \quad \epsilon_2 = \omega''_0 T^2 / \Gamma, \quad |\epsilon_{1,2}| \ll 1,$$

where

$$R_L(\Gamma, \Delta) = \Gamma / (\Gamma^2 + \Delta^2), \quad (25)$$

$$\bar{R}(\Gamma, \Delta) = \Gamma(\Gamma^2 - \Delta^2) / (\Gamma^2 + \Delta^2)^2.$$

[Equation (24) can be obtained also by solving with perturbation theory in  $\epsilon_1, \epsilon_2$  the set of difference equations for the moments,

$$N_m(\Omega) = \int_0^\infty dE E^{m+1/2} W_1(E, \Omega)$$

(cf. Ref. 4); obviously  $Q(\Omega) \propto N_1(\Omega)$ ].

It is evident from (24) that, to second order in  $\delta\omega$ , the peak in  $Q(\Omega)$  remains symmetrical. It becomes non-Lorentzian, however, and its HWHM may be seen to be given by the expression

$$\delta\Omega = \Gamma [1 + \frac{13}{15}(\epsilon_1 + 3\epsilon_2)^2 + \frac{93}{130}\epsilon_2^2]. \quad (26)$$

So far, for finite noise intensity,  $\delta\Omega$  exceeds its zero- $T$  limit  $\Gamma$ . However, within the range

$$-5.27\epsilon_2 < \epsilon_1 < -3.73\epsilon_2$$

the derivative  $d\delta\Omega/dT$  is seen to be negative. This implies a *narrowing* of the peak in the spectral density of the fluctuations with increasing noise intensity. Thus the unexpected phenomenon of noise-induced narrowing occurs even within the small- $T$  regime where perturbation theory is applicable.

With increasing  $T$ , when frequency straggling becomes the dominant broadening mechanism, the shape of the peak is described near its maximum by the function  $x \exp(-x)$ , where  $x = (\Omega - \omega_0) / \omega'_0 T$ , if  $|\omega'_0| T \gg \Gamma$ ,  $|\omega''_0| T^2$ . [It reproduces the function  $q_1^2(E) w_{st}(E) \propto E \exp(-E/T)$  with  $E = (\Omega - \omega_0) / \omega'_0$  and  $q_1(E)$  given by (17), i.e., the product of the squared amplitude of the vibrations with the proper eigenfrequency  $\omega(E) = \Omega$  multiplied by their population.] This function is strongly asymmetric: it is steeper on the side adjacent to  $\omega_0$ . Just such asymmetry is evident in the curves and data of Figs. 2–4.

### B. Narrowing of the spectral peak for intermediate noise intensities

The noise-induced peak-narrowing phenomenon is most pronounced if the eigenfrequency  $\omega(E)$  has an extremum at some  $E = E_e$ ; that is, if (1) is fulfilled and, in addition,  $|\omega'_0| E_e \gg \Gamma$ . This condition guarantees that frequency straggling is the major source of peak broadening for intermediate noise intensities.

As noted in Sec. I, it was shown in Ref. 13 that an additional "zero-dispersion" peak can arise in  $Q(\omega)$  at frequency  $\Omega \simeq \omega(E_e)$  with a characteristic half-width  $\sim (\Gamma T |\omega_e''| p_e^2)^{1/2}$ , where the  $e$  subscripts show that the quantities in question are calculated for  $E = E_e$ . The zero-dispersion peak is pronounced provided damping is sufficiently small,  $(\Gamma p_e^2 / |\omega_e''|)^{1/4} \ll T^{3/4}$ . Its height is proportional to  $(\Gamma p_e^2 T)^{-1/4} w_{st}(E_e)$ . The peak is strongly asymmetric:  $Q(\Omega)$  decreases very sharply in the range  $(\Omega - \omega_e) / \omega_e'' < 0$  because there are no eigenfrequencies of the system with eigenfrequencies  $\omega(E) = \Omega$  in this range.

Unless the damping is extremely small (in practice, a rather strong limitation), the zero-dispersion peak is not resolved. However, the cutoff of the eigenfrequencies at  $\Omega = \omega_e$  can still give rise to a substantial narrowing of the peak of  $Q(\Omega)$  with increasing noise. Indeed, in the range  $\Gamma / |\omega_0'| < T \ll E_e$ , the peak near the frequency  $\omega_0$  broadens with increasing  $T$  as discussed above and, for  $T \gg \Gamma / |\omega_0'|$ , its characteristic width becomes  $\sim |\omega_0'| T$ . Thus, relaxation-induced broadening is not substantial near the maximum. The position of the maximum shifts approximately as  $\omega_0' T$ ; that is, it shifts towards the cutoff frequency  $\omega_e$ , and the peak becomes steeper on its  $\omega_0$  side as already mentioned above. At sufficiently large  $T$ , however, the frequency cutoff becomes important and the peak then starts to narrow with further increase of  $T$ . The peak is being "pressed" up against  $\omega_e$ : vibrations with higher and higher amplitudes are being excited, and their eigenfrequency approaches  $\omega_e$ ; but there are no eigenfrequencies beyond the cutoff. As a result, the peak becomes steeper on the  $\omega_e$  side, i.e., the exact opposite of the situation for small  $T$ . In addition, the effects of relaxation become important in this range [since, otherwise,  $Q(\Omega)$  would diverge], i.e., the broadening of the peak is determined more by the "weaker" mechanism (relaxation) than by the mechanism (frequency straggling) which was operative in  $\Gamma / |\omega_0'| \ll T \ll E_e$ .

These qualitative arguments are confirmed by the direct computations and explain the narrowing of the spectral peaks observed experimentally. The broadening, subsequent narrowing, and shape changes (including interchange of the steeper side) of the peak with increasing noise intensity are clearly visible in Fig. 4. The dependence of the HWHM on the noise intensity parameter  $T$  for different values of the inclination parameter  $A$  is shown in Fig. 6(a). The effect of narrowing is pronounced for  $|A| > 0.43$  when the function  $\omega(E)$  has a minimum. For the parameter values used in the experiment, the narrowing is strongest in the range  $|A| > 1$ , where the difference  $(\omega_0 - \omega_e)$  exceeds  $\Gamma$  appreciably. We note that for high noise intensities  $T > E_e$  the spectral peak for the model (2) again broadens with increasing  $T$  because of the contribution of vibrations with high energies whose frequencies differ substantially from  $\omega_e$  (cf. Fig. 1).

## V. CONCLUSION

It follows from the experimental data and the theory presented above that there exists a class of nonlinear systems for which, in contrast to the usual noise-induced

broadening of the peaks of the spectral densities of fluctuations (which was commonly supposed to be the general rule), there is a noticeable narrowing of spectral peaks with increasing noise intensity. These are underdamped vibrational systems with non-monotonic dependences of the eigenfrequencies of their vibrations upon their energy. The phenomenon is quite general: it is not restricted to the particular model (2) investigated. In the course of the narrowing there are substantial changes in the shape of the spectral peak due to the different broadening mechanisms that are responsible for its formation. These changes, and the effect of the narrowing, must certainly affect not only the peaks in the spectral densities of the fluctuations, but also those in the susceptibilities.

We note in conclusion that the above results are valid for a much broader class of underdamped fluctuating vibrational systems than those described by the model of a Brownian particle. They are relevant, for example, to a variety of vibrational subsystems weakly coupled to a thermal bath, including localized and resonant vibrations in solids. The stationary distribution of such systems is Gibbsian, just like that for a Brownian particle. For the model to be applicable, the characteristic time for relaxation and the correlation time ("color") of the noise resulting from the coupling to the bath should both be small compared, not to the period of the vibrations  $\sim \omega_0^{-1}$ , but to a much longer time interval  $\sim \Gamma^{-1}$  (cf. Refs. 4 and 7). However, the effective friction coefficients, which determine the drift of the energy for both small ( $E \ll 1$ ) and relatively large ( $E \sim E_e$ ) energies (and which influence the shape of the spectra in the small- $T$  limit and in the region of the strongest noise-induced narrowing, respectively) can differ somewhat from each other. It would be interesting, therefore, to try to observe the effects described above for the case of, say, an impurity atom in a solid where the relevant parameters can be varied by means of external fields.

## ACKNOWLEDGMENTS

We are much indebted to Dr. C. J. Lambert and Dr. N. Stein for a critical reading of this paper. Two of us would like to acknowledge the financial support respectively of the Science and Engineering Research Council (MID) and the Royal Society (SMS), and warm hospitality during their stay in Lancaster University. One of us (P.V.E.McC.) wishes to thank the Institute of Semiconductors of the Ukrainian Soviet Socialist Republic Academy of Sciences for its hospitality during a memorable visit to Kiev, leading directly to the research reported above. The experimental program at the University of Lancaster was supported by the Science and Engineering Research Council (U. K.).

## APPENDIX

To obtain the expressions for the coefficients  $\overline{p^2(E)}$ ,  $(q_E)^2$ ,  $q_1(E)$  in (16), we note first that the solution of the conservative equation of motion of the oscillator under consideration,



$$\frac{\partial p}{\partial \phi} = -\omega^{-1}(E) \frac{\partial U}{\partial q}, \quad \frac{\partial q}{\partial \phi} = \omega^{-1}(E) p, \quad (\text{A1})$$

can easily be expressed in terms of the Jacobian elliptic functions<sup>18</sup> and shown to be of the form

$$q(E, \phi) = \frac{q^{(1)}z^{(2)} + q^{(2)}z^{(1)} - (q^{(1)}z^{(2)} - q^{(2)}z^{(1)})\text{cn}v}{z^{(1)} + z^{(2)} + (z^{(1)} - z^{(2)})\text{cn}v}, \quad (\text{A2})$$

$$v = \frac{2K(k)}{\pi} \phi,$$

where the values of  $q^{(1,2)}$ ,  $z^{(1,2)}$  and of the modulus  $k$  for a given energy  $E$  are determined by (4a) and (4b).

To calculate the Fourier components

$$q_n(E) = \frac{1}{2\pi} \int_{-\pi}^{\pi} d\phi \exp(-in\phi) q(E, \phi) \quad (\text{A3})$$

we note, allowing for the double periodicity of the elliptic cosine

$$\text{cn}(v + 4K) = \text{cn}(v + 2K + 2iK') = \text{cn}v, \quad (\text{A4})$$

$$K' = K'(k) = K(\sqrt{1-k^2}),$$

that

$$q_n(E) = [1 - (-1)^n e^{n\pi K'/K}] \frac{1}{2\pi} \int_C d\phi \exp(-in\phi) q(E, \phi), \quad (\text{A5})$$

where the contour  $C$  is as shown in Fig. 7. The function  $q(E, \phi)$  is seen from (A2) to have two poles inside the area bounded by the contour  $C$ , at the points  $P_1$  (where  $\phi = i\psi_p$ ) and  $P_2$  (where  $\phi = \pi + i\pi K'/K - i\psi_p$ ), with  $\psi_p$  being the solution of the equation

$$\text{cn} \left[ \frac{2K(k)}{\pi} \psi_p | \sqrt{1-k^2} \right] = -\frac{z^{(1)} - z^{(2)}}{z^{(1)} + z^{(2)}}. \quad (\text{A6})$$

It follows from (A2), (A5), and (A6), with due account taken of known expressions<sup>18</sup> for  $d\text{cn}v/du$  and of (4a) and (4b), that

$$q_n(E) = \frac{\pi \sqrt{z^{(1)}z^{(2)}}}{2K} \times \frac{\exp(n\psi_p) - (-1)^n \exp[(\pi n K'/K) - n\psi_p]}{1 - (-1)^n \exp(\pi n K'/K)}, \quad n \neq 0. \quad (\text{A7})$$

Since  $q^{(1)}$  and  $q^{(2)}$  are the limiting points of the motion, they correspond to  $q(E, \phi)$  with  $\phi = 0$  and  $\phi = \pi$ , respectively. Therefore,

$$q_0(E) = \frac{1}{2}(q^{(1)} + q^{(2)}) - 2 \sum_{n>0} q_{2n}(E). \quad (\text{A8})$$

Equation (A7) with  $n=1$  gives  $q_1(E)$  in (16). The quantities  $\overline{p^2}$ ,  $\overline{(q_E)^2}$  are given by

$$\overline{p^2(E)} = \omega^2(E) \sum_{m=-\infty}^{\infty} m^2 q_m^2(E), \quad (\text{A9})$$

$$\overline{(q_E)^2} = \sum_{m=-\infty}^{\infty} \left[ \frac{dq_m(E)}{dE} \right]^2.$$

For the noise intensities and values of  $A$  investigated in the present paper, where  $E$  was restricted to  $E < 10$ , it was sufficient to limit the summation in (A9) to  $|m| = 4$ , yielding an accuracy of  $\sim 10^{-8}$ .

\*Now at: Dipartimento di Fisica, Università di Pisa, Piazza Torricelli 2, 56100 Pisa, Italy.

<sup>1</sup>L. D. Landau and E. M. Lifshitz, *Statistical Physics*, 3rd ed. (Pergamon, New York, 1980), Part 1, revised by E. M. Lifshitz and L. P. Pitaevskii.

<sup>2</sup>J. B. Morton and S. Corrsin, *J. Stat. Phys.* **2**, 153 (1970).

<sup>3</sup>M. A. Krivoglaз and I. P. Pinkevich, *Ukr. Fiz. Zh.* **15**, 2039 (1970); Y. Onodera, *Prog. Theor. Phys.* **44**, 1477 (1970).

<sup>4</sup>M. I. Dykman and M. A. Krivoglaз, *Phys. Status Solidi B* **48**, 497 (1971).

<sup>5</sup>R. F. Rodriguez and N. G. van Kampen, *Physica* **85A**, 347 (1976).

<sup>6</sup>K. Sture, J. Nordholm, and R. Zwanzig, *J. Stat. Phys.* **11**, 143 (1974).

<sup>7</sup>M. I. Dykman and M. A. Krivoglaз, *Physica* **104A**, 495 (1980).

<sup>8</sup>B. Carmeli and A. Nitzan, *Phys. Rev. A* **32**, 2439 (1985).

<sup>9</sup>J. J. Brey, J. M. Casado, and M. Morillo, *Physica* **123A**, 481 (1989).

<sup>10</sup>W. Renz, *Z. Phys. B* **59**, 91 (1985); L. Fronzoni, P. Grigolini, R. Mannella, and B. Zambon, *J. Stat. Phys.* **41**, 553 (1985); *Phys. Rev. A* **34**, 3293 (1986); W. Renz and F. Marchesoni,

*Phys. Lett.* **112A**, 124 (1985).

<sup>11</sup>M. I. Dykman and M. A. Krivoglaз, in *Soviet Physics Reviews*, edited by I. M. Khalatnikov (Harwood, New York, 1984), Vol. 5, p. 265.

<sup>12</sup>H. Risken, *The Fokker-Planck Equation*, 2nd ed. (Springer-Verlag, Berlin, 1989).

<sup>13</sup>S. M. Soskin, *Physica* **155A**, 401 (1989).

<sup>14</sup>A. S. Barker, Jr. and A. J. Sievers, *Rev. Mod. Phys.* **47**, S1 (1975).

<sup>15</sup>M. I. Dykman, M. A. Krivoglaз, and S. M. Soskin, in *Noise in Nonlinear Dynamical Systems*, edited by F. Moss and P. V. E. McClintock (Cambridge University Press, Cambridge, 1989), Vol. 2, p. 347.

<sup>16</sup>M. I. Dykman, R. Mannella, P. V. E. McClintock, S. M. Soskin, and N. G. Stocks, *Phys. Rev. A* (to be published).

<sup>17</sup>P. V. E. McClintock and F. Moss, in *Noise in Nonlinear Dynamical Systems*, edited by F. Moss and P. V. E. McClintock (Cambridge University Press, Cambridge, 1989), Vol. 3, p. 243.

<sup>18</sup>*Handbook of Mathematical Functions*, edited by M. Abramowitz and I. Stegun (Dover, New York, 1970).